

**GERSTEL**

AppNote 7/2010

GERSTEL Automated Liner Exchange (ALEX) and its Benefits in GC Pesticide Analysis

Oliver Lerch

*Gerstel GmbH & Co. KG, Eberhard-Gerstel-Platz 1,
D-45473 Mülheim an der Ruhr, Germany*

KEYWORDS

Pesticide Analysis, Matrix Effects, QuEChERS, Automated Liner Exchange (ALEX), Cooled Injection System (CIS)

ABSTRACT

Fruit and vegetable extracts that are produced following the well established QuEChERS method [1,2] typically contain a significant amount of involatile matrix material. After several injections of such extracts into the GC, sufficient matrix residue will be present in the GC inlet liner to lower or sometimes even increase the response of certain pesticide compounds affecting the accuracy of the analysis. The performance can be restored by exchanging the GC inlet liner. Normally this has to be done manually which means stopping the analysis sequence.

The GERSTEL Automated Liner Exchange system (ALEX) provides an automated solution. As this study shows, automated liner exchange restores the original performance of the GC system and is therefore generally useful for the analysis of extracts that contain involatile matrix residue.

INTRODUCTION

In this study a spinach extract spiked with 60 pesticides was used to reveal effects of involatile matrix residue precipitated in the GC inlet liner. Raw, uncleaned extract was injected repeatedly and analyte discrimination effects demonstrated after just a few injections. It was shown that automated liner exchange using the GERSTEL ALEX technology restored the analysis system to its original performance enabling

GC-based routine analysis of large numbers of QuEChERS extracts.

EXPERIMENTAL

Instrumentation. Analyses were performed using a 6890 GC equipped with a 5975 Mass Selective Detector (Agilent Technologies), Cooled Injection System (CIS 4) Automated Liner Exchange system (ALEX) and MultiPurpose Sampler (MPS, all GERSTEL).

Every GERSTEL CIS 4 can be upgraded with ALEX by mounting the ALEX accessory onto the injector. Large volume injections with solvent evaporation are possible exactly as known from the CIS. The inlet liner used for the ALEX system is a standard CIS liner equipped with a transport adapter. The adapter has a replaceable septum for injection into the liner. The transport adapter also serves the purpose of sealing and pneumatically locking the liner onto the CIS and maintaining the gas supply through the GC inlet and column. The MPS autosampler is equipped with a gripper which can grab and move the transport adapter. Using the MPS, the liner can be exchanged automatically. Replacement liners are kept in sealed glass tubes in a dedicated storage tray. The ALEX system can also be configured with a manual control box enabling easy manual liner exchange without the need for tools.

Analysis conditions.

ALEX:

Liner	Empty liner with one notch
Injection	5 μ L large volume injection
Pneumatics	0.2 min solvent vent (50 mL/min) Splitless 2.3 min
Temperature	70°C; 3°C/s; 300°C (3 min); 12°C/s; 280°C (10 min)

GC:

Oven	70°C (2 min); 25°C/min; 150°C; 3°C/min; 200°C; 8°C/min; 280°C (10 min)
Column	30 m Rxi-5ms (Restek) di = 0.25 mm df = 0.25 μ m
Pneumatics	He, constant pressure = 104.3 kPa Retention Time Locked (RTL) with chlorpyrifos-methyl

Detector:

MSD	EI mode, SIM
-----	--------------

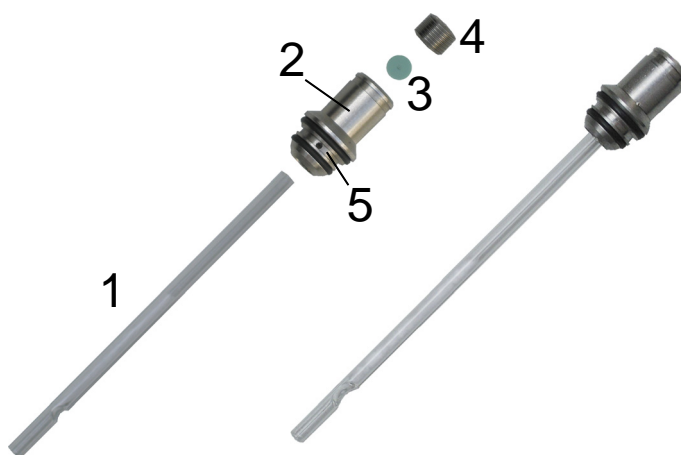

Figure 1. Left: Exploded view of transport adapters for automated liner exchange with liner (1), adapter (2), 3x5mm septum (3) and septum screw (4); between the o-rings of the transport adapter, the orifice (5) can be seen, which is used to connect the adapter to the carrier gas supply. Right: Transport adapter with liner.



Figure 2. MultiPurpose Sampler (MPS) equipped with gripper for automated liner exchange. The 14-position ALEX liner tray is shown to the right.

Sample Preparation. A frozen sample of organically grown spinach was homogenized and extracted with acetonitrile as described in the QuEChERS procedure [1]. The cleanup step was left out and the raw extract was spiked at 50 pg/ μ L (50 μ g/kg spinach) with a pesticide mixture containing 60 pesticides. The resulting solution was used for repeat injections into the ALEX system.

Table 1. Table of analytes with retention times and masses monitored in SIM mode.

Analyte	Retention Time [min]	Mass [amu]
Biphenyl	7,09	154
2-Phenylphenol	8,79	170
Diphenylamine	10,5	169
Chlorpropham	11,05	213
Trifluralin	11,64	306
Dimethoate	12,69	143
Ethoxyquin	12,83	202
Terbutylazin	13,85	214
Propyzamide	13,97	173
Pyrimethanil	14,21	198
Chlorothalonil	14,8	266
Pirimicarb	15,7	166
Chlorpyrifos-methyl	16,61	286
Carbaryl	16,84	144
Metalaxyl	17,37	160
Pirimiphos-methyl	18,3	290
Malathion	18,79	173
Chlorpyrifos-ethyl	19,24	314
Triadimefon	19,44	208
Tetraconazole	19,89	336
Cyprodinil	20,63	224
Pendimethalin	21,01	252
Penconazol	21,08	248
Tolyfluanid	21,24	238
Triadimenol	21,73	168
Procymidone	21,98	283
Methidathion	22,31	145
Endosulfan alpha	22,68	237
Hexaconazole	23,57	214
Fludioxonil	24,12	248
Myclobutanil	24,5	179
Flusilazole	24,66	233
Bupirimate	24,84	273
Kresoxim-methyl	24,89	116

Analyte	Retention Time [min]	Mass [amu]
Endosulfan beta	25,19	237
Ethion	25,98	231
Pyrethrin I	26,65	123
Endosulfan-sulfat	26,78	387
Quinoxifen	26,79	307
Fenhexamid	26,92	177
Trifloxystrobin	27,26	116
Tebuconazole	27,46	250
Piperonylbutoxid	27,88	176
Iprodione	28,41	189
Phosmet	28,49	160
Bifenthrin	28,82	181
Tebufenpyrad	29,07	318
Fenazaquin	29,09	145
Pyriproxyfen	29,84	136
Mirex	29,86	272
Cyhalothrin lambda	30,34	181
Fenarimol	30,42	251
Spirodiclofen	31,33	312
Pyridaben	31,5	147
Prochloraz	31,77	180
Boscalid	32,71	140
Etofenprox	33,11	163
Difenoconazol I	35,06	323
Difenoconazol II	35,21	323
Azoxystrobin	36,47	344
Dimethomorph	37,37	301

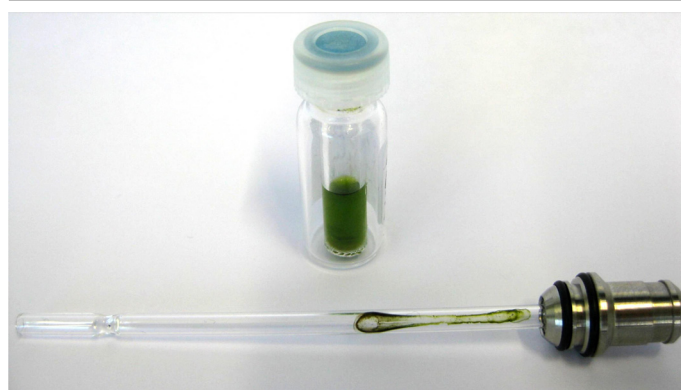

Figure 3. Spinach extract and ALEX liner after several injections.

Measurements. Series of 5 μ L samples of spiked raw spinach extract were injected into the ALEX/CIS inlet and analyzed. The first series spanned 20 injections with a liner exchange after 10 injections. The second series spanned 20 injections with liner exchange every 5 injections. After each liner exchange and at the start

of every sequence one injection of the extract was performed in order to condition the liner, the chromatograms that resulted from the conditioning steps were not evaluated.

RESULTS AND DISCUSSION

Figure 4 shows results of the first series of 20 injections with liner exchange after every 10 injections for four compounds selected specifically since they are not affected by matrix effects. An internal standard is not taken into account. The relative standard deviations are quite acceptable and they are improved when an internal standard is used in the calculations (figure 5). In this case, tetraconazole which is also not affected by matrix effects was chosen as internal standard. For these compounds an automated liner exchange after 10 injections is not needed and, as can be seen, they are not influenced by the liner exchange either. 48 of the 60 compounds were not affected by matrix effects after this number of injections.

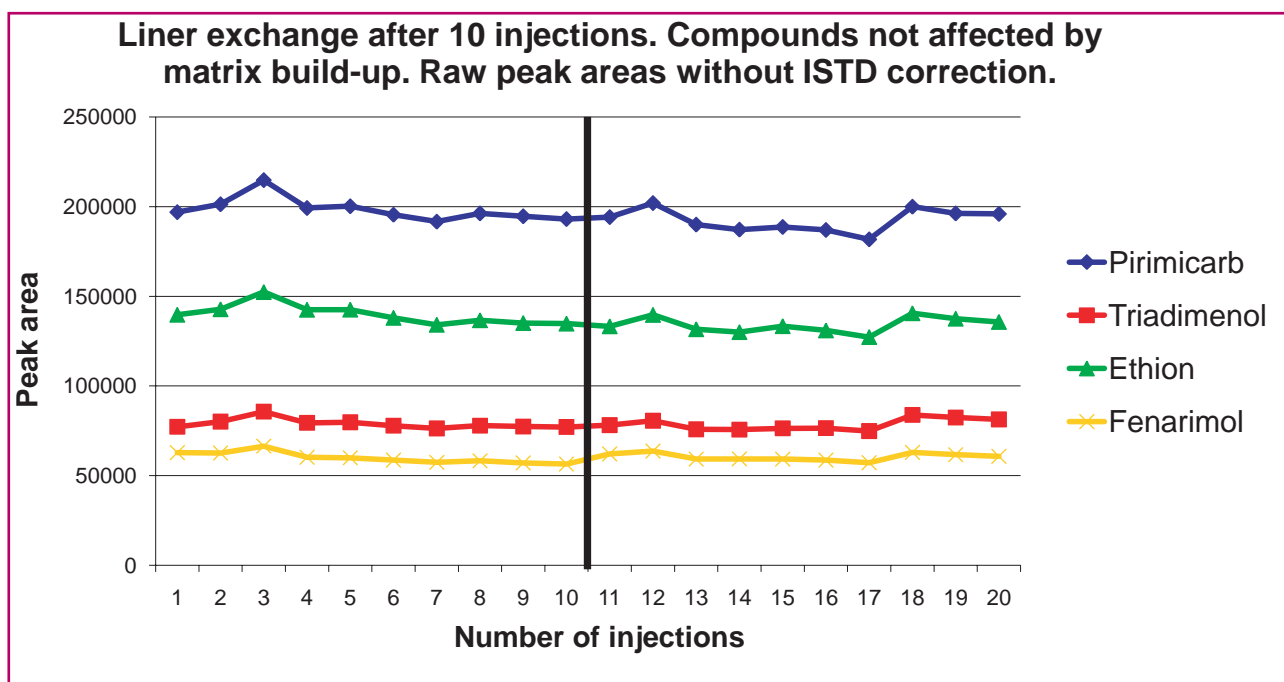

Figure 4. Results from a series of 20 injections with liner exchange every 10 injections.

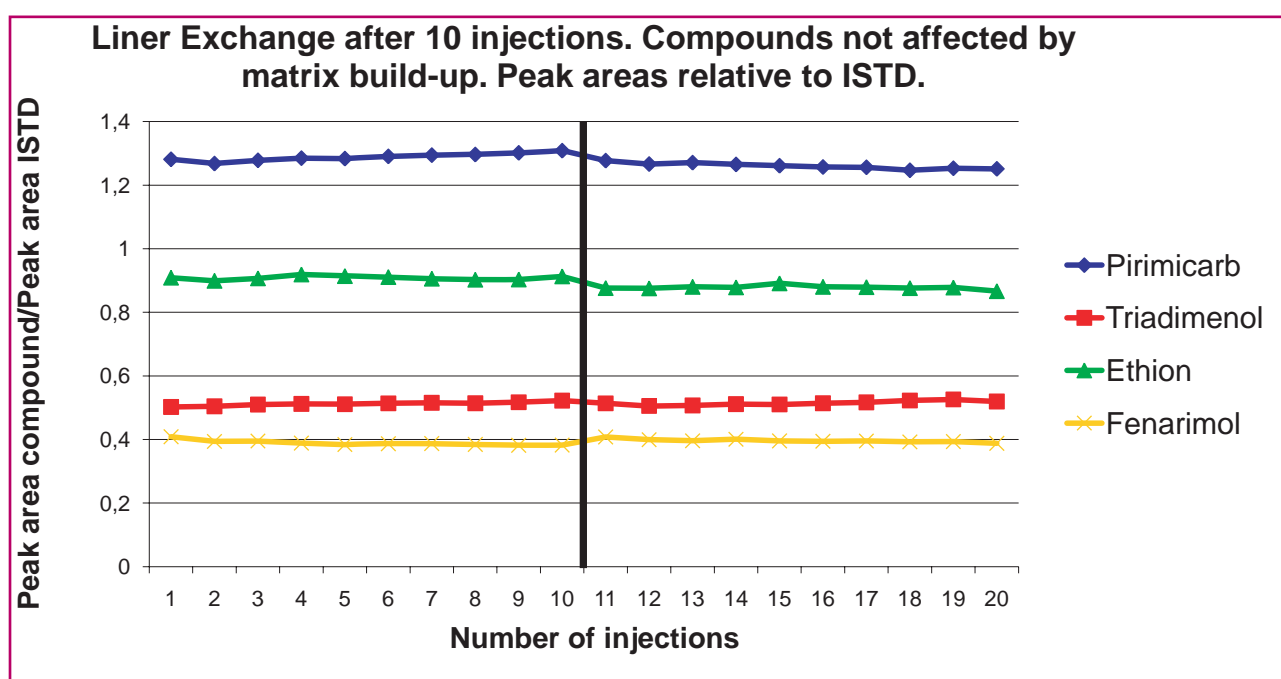

Figure 5. Results from a series of 20 injections with liner exchange every 10 injections.

Figure 6 shows results of the first series of 20 injections with liner exchange after 10 injections for four compounds that are strongly affected by matrix effects. For dimethoate a matrix induced enhancement can be observed. For all other compounds a decrease of peak areas can be seen. Performing the calculations based on the internal standard tetraconazole does not change the picture (figure 7). Using a deuterated internal standard for each of the critical compounds could improve the situation. 12 of the 60 compounds are affected by matrix effects.

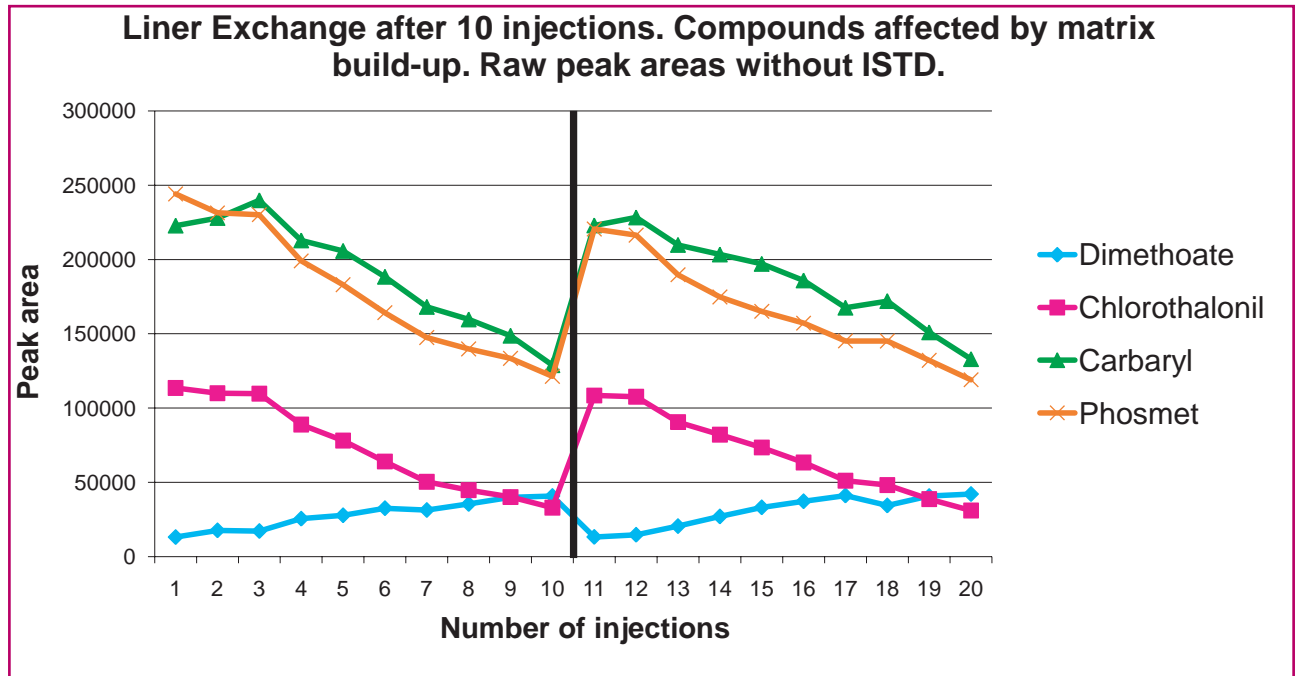

Figure 6. Results from a series of 20 injections with liner exchange every 10 injections.

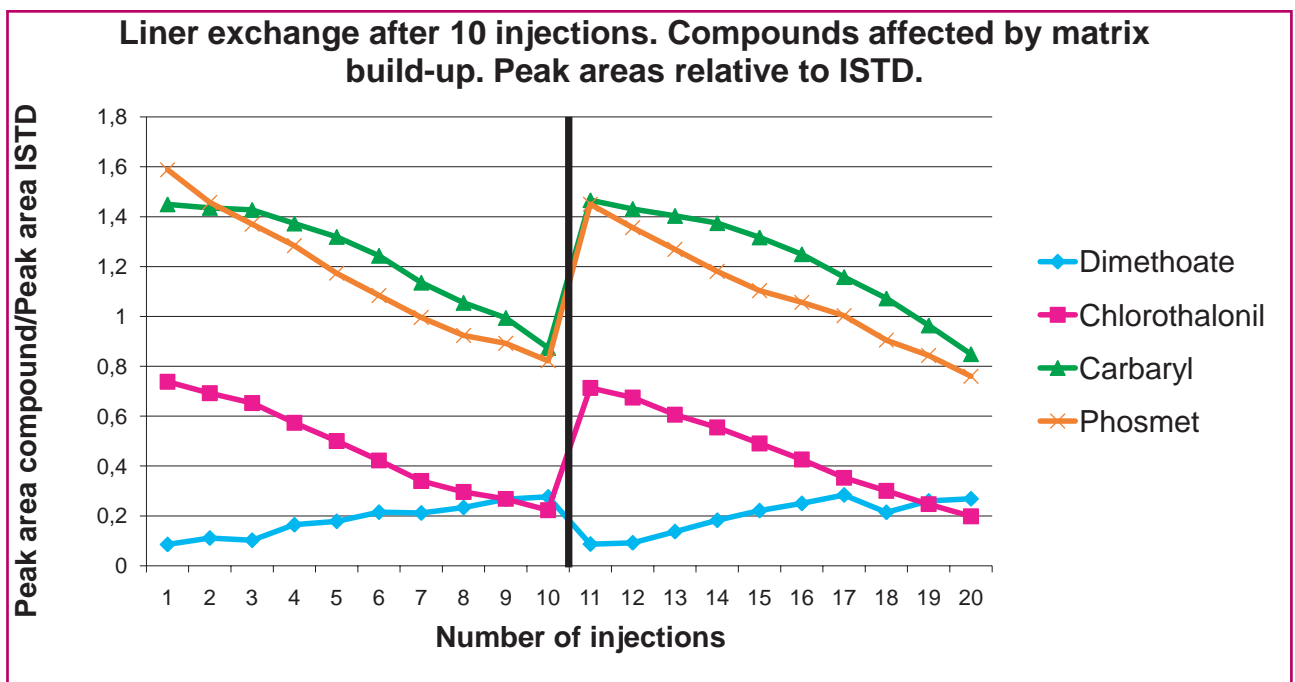

Figure 7. Results from a series of 20 injections with liner exchange every 10 injections.

By exchanging the liner for every 5 injections the variation of the peak areas and the relative standard deviations for compounds that are susceptible to matrix effects can be improved markedly as can be seen by comparing the results in figures 7 and 9.

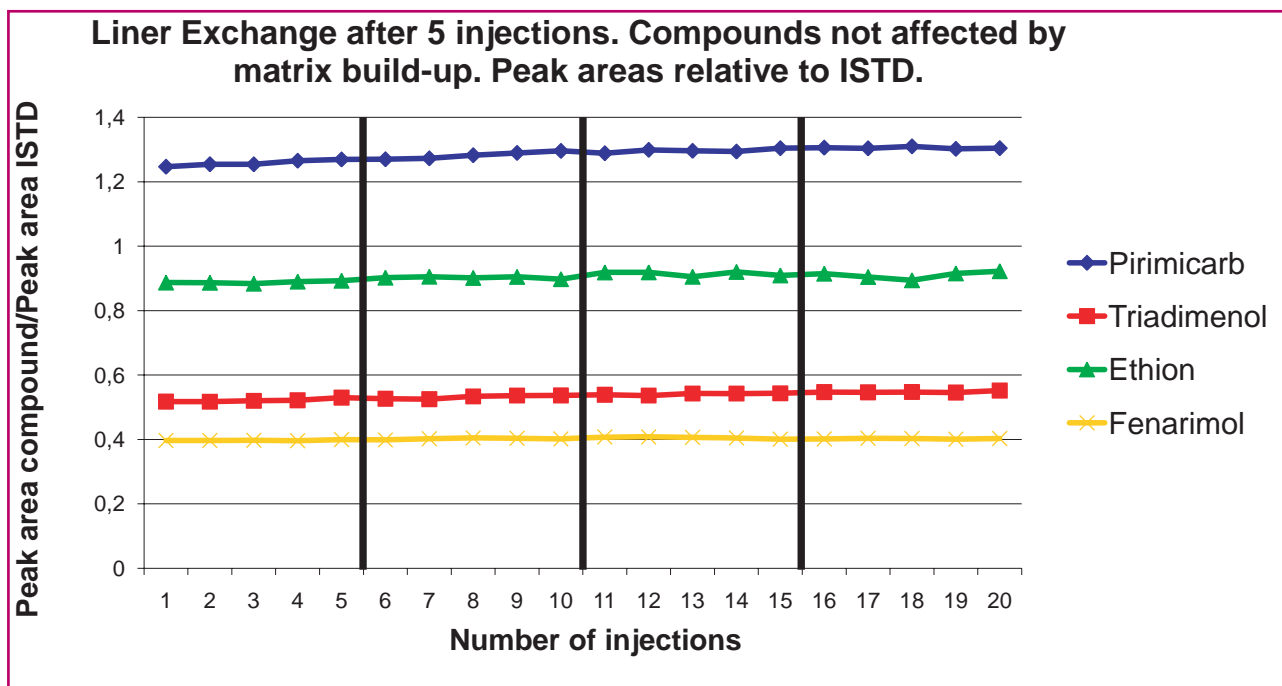

Figure 8. Results from a series of 20 injections with liner exchange every 5 injections.

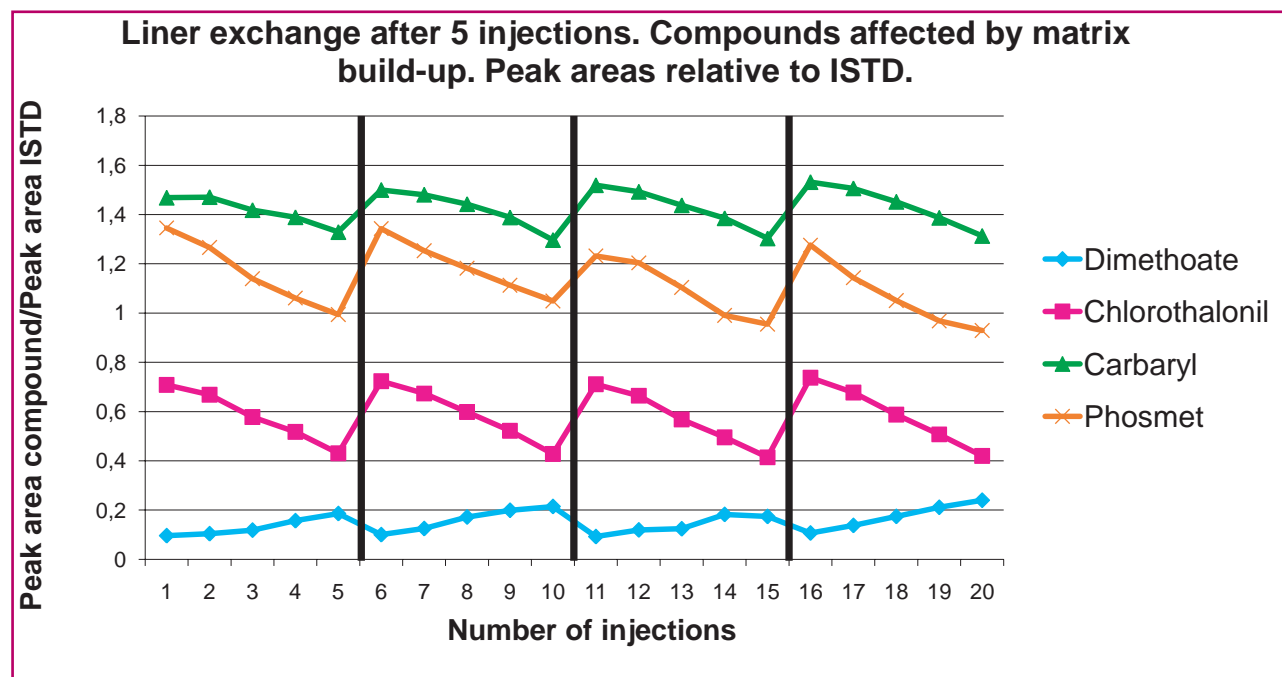

Figure 9. Results from a series of 20 injections with liner exchange every 5 injections.

A cleanup of the extract with primary secondary amine (PSA), graphitized carbon black (GCB) and MgSO₄ as described in the QuEChERS method [1] was also performed. In this case, the clean-up didn't improve the chromatographic performance of most of the critical components and it would therefore seem reasonable to leave out the cleanup step.

It is important to note that the original response of the critical compounds can be restored by automated liner exchange, as can be seen in the figures 6, 7, 9 and 11. This clearly proves that the ALEX system works as intended and that it is a powerful tool for handling samples with a high matrix load.

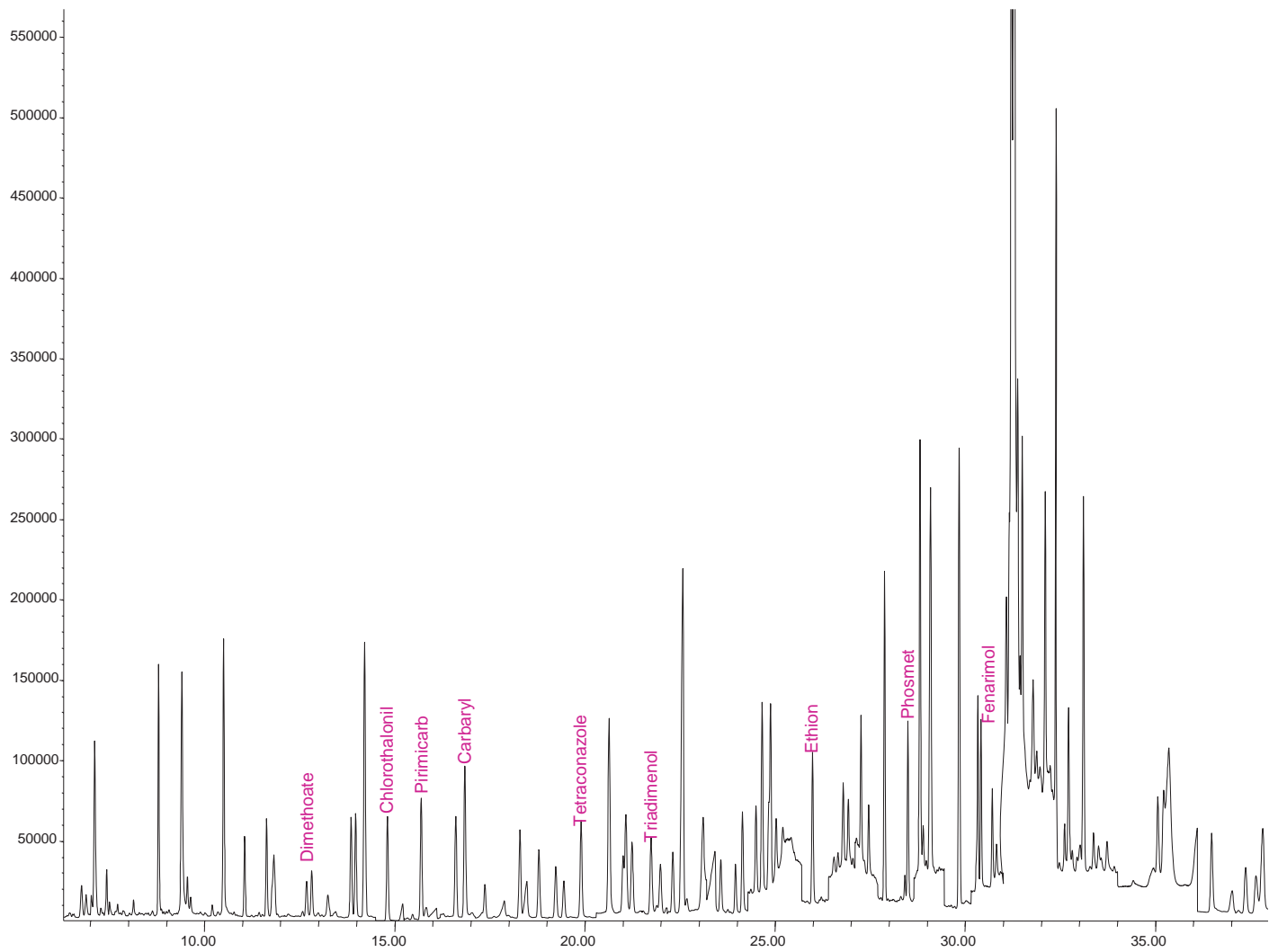

Figure 10. SIM chromatogram of 50 pg/μL of 60 pesticides in raw spinach extract.

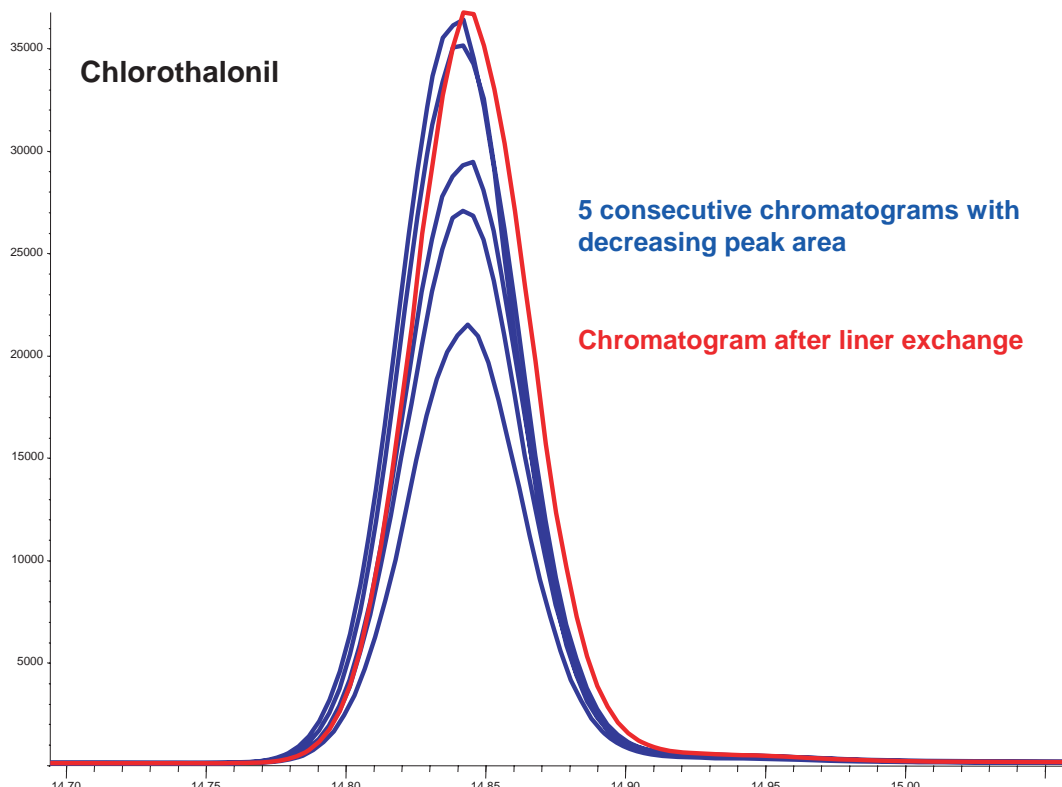

Figure 11. SIM chromatograms of chlorothalonil before and after liner exchange. Liner exchange restores previous performance.

Table 2. List of analytes with the RSDs achieved for 20/10 and 20/5 injections and ISTD.

Analyte	20 Runs, Liner Exchange	
	after 10 Runs	after 5 Runs
	RSD [%]	RSD [%]
Biphenyl	5,5	4,5
2-Phenylphenol	1,0	2,1
Diphenylamine	1,8	3,0
Chlorpropham	0,8	1,6
Trifluralin	1,3	1,5
Dimethoate	35,9	29,6
Ethoxyquin	68,7	23,8
Terbutylazin	2,2	2,5
Propyzamide	0,9	1,0
Pyrimethanil	1,3	1,6
Chlorothalonil	38,7	19,0
Pirimicarb	1,4	1,5
Chlorpyrifos-methyl	3,2	1,5
Carbaryl	16,5	5,2
Metalaxyl	0,8	2,1
Pirimiphos-methyl	1,5	1,0
Malathion	2,7	2,5
Chlorpyrifos-ethyl	1,1	0,7
Triadimefon	0,9	1,6
Tetraconazole	0,0	0,0
Cyprodinil	0,9	1,3
Pendimethalin	4,3	2,9
Penconazol	1,0	0,9
Tolyfluanid	43,1	13,8
Triadimenol	1,2	2,0
Procymidone	1,0	1,1
Methidathion	8,1	3,4
Endosulfan alpha	1,4	1,7
Hexaconazole	0,9	1,3
Fludioxonil	1,4	1,3
Myclobutanil	1,2	1,6
Flusilazole	0,5	1,0
Bupirimate	3,4	3,2
Kresoxim-methyl	0,7	2,0
Endosulfan beta	7,0	2,3
Ethion	1,9	1,3
Pyrethrin I	4,5	1,9
Endosulfan-sulfat	20,7	9,3
Quinoxifen	1,2	0,6
Fenhexamid	2,2	2,8
Trifloxystrobin	3,1	3,8
Tebuconazole	0,9	0,7

Analyte	20 Runs, Liner Exchange	
	after 10 Runs	after 5 Runs
	RSD [%]	RSD [%]
Piperonylbutoxid	1,2	2,1
Iprodione	9,1	4,2
Phosmet	21,2	11,5
Bifenthrin	0,7	1,5
Tebufenpyrad	0,9	0,4
Fenazaquin	0,7	1,6
Pyriproxyfen	1,1	1,8
Mirex	25,8	9,5
Cyhalothrin lambda	3,7	1,9
Fenarimol	1,9	0,9
Spirodiclofen	9,1	3,8
Pyridaben	1,5	1,5
Prochloraz	3,7	4,9
Boscalid	1,1	1,0
Etofenprox	1,3	1,4
Difenoconazol I	1,3	1,0
Difenoconazol II	1,4	0,9
Azoxystrobin	2,1	0,7
Dimethomorph	1,3	1,0

CONCLUSIONS

It was shown in this work that automated liner exchange (ALEX) can restore analytical performance for GC/MS determination of pesticides in matrix laden extracts. This tool enables automated GC-analysis of large batches of samples that are relatively "dirty" without manual intervention and without compromising the accuracy of the results.

ALEX provides additional possibilities for most pesticide laboratories when combined with other techniques such as adding analyte protectants [3,4,5], using a guard column or performing column backflushing [6].

In summary, ALEX enables the analyst to successfully and productively run even large series of samples that contain a significant amount of matrix.

REFERENCES

- [1] EN 15662:2008: "Foods of plant origin – Determination of pesticide residues using GC-MS and/or LC-MS/MS following acetonitrile extraction/partitioning and clean-up by dispersive SPE – QuEChERS-method"
- [2] AOAC Official Method 2007.1: "Pesticide residues in foods by acetonitrile extraction and partitioning with magnesium sulfate. Gas chromatography/mass spectrometry and liquid chromatography/tandem mass spectrometry"
- [3] M. Anastassiades, K. Mastovska, S.J. Lehotay: "Evaluation of analyte protectants to improve gas chromatographic analysis of pesticides", *J. Chromatogr. A* 1015 (2003), 163-184
- [4] K. Mastovska, S.J. Lehotay, M. Anastassiades: "Combination of analyte protectants to overcome matrix effects in routine GC analysis of pesticide residues in food matrixes", *Anal. Chem.* 77 (2005), 8129-8137
- [5] C. Sanchez-Brunete, B. Albero, G. Martin, J. Tadeo: "Determination of pesticide residues by GC-MS using analyte protectants to counteract the matrix effect", *Anal. Sci.* 21 (2005), 1291-1296
- [6] L. Zhao, P.L. Wylie, J. Stevens: "Analysis of Pesticide Residues in Apple Using Agilent SampliQ QuEChERS EN Kits by GC/MS", Agilent Technologies Publication 5990-4073EN



GERSTEL GmbH & Co. KG

Eberhard-Gerstel-Platz 1
45473 Mülheim an der Ruhr
Germany

☎ +49 (0) 208 - 7 65 03-0
☎ +49 (0) 208 - 7 65 03 33
@ gerstel@gerstel.com
🌐 www.gerstel.com

GERSTEL Worldwide

GERSTEL, Inc.

701 Digital Drive, Suite J
Linthicum, MD 21090
USA

☎ +1 (410) 247 5885
☎ +1 (410) 247 5887
@ sales@gerstelus.com
🌐 www.gerstelus.com

GERSTEL AG

Wassergrabe 27
CH-6210 Sursee
Switzerland

☎ +41 (41) 9 21 97 23
☎ +41 (41) 9 21 97 25
@ swiss@ch.gerstel.com
🌐 www.gerstel.ch

GERSTEL K.K.

1-3-1 Nakane, Meguro-ku
Tokyo 152-0031
SMBC Toritsuudai Ekimae Bldg 4F
Japan

☎ +81 3 5731 5321
☎ +81 3 5731 5322
@ info@gerstel.co.jp
🌐 www.gerstel.co.jp

GERSTEL LLP

Level 25, North Tower
One Raffles Quay
Singapore 048583

☎ +65 6622 5486
☎ +65 6622 5999
@ SEA@gerstel.com
🌐 www.gerstel.com

GERSTEL Brasil

Av. Pascoal da Rocha Falcão, 367
04785-000 São Paulo - SP Brasil

☎ +55 (11)5665-8931
☎ +55 (11)5666-9084
@ gerstel-brasil@gerstel.com
🌐 www.gerstel.com.br

Information, descriptions and specifications in this Publication are subject to change without notice. GERSTEL, GRAPHPACK and TWISTER are registered trademarks of GERSTEL GmbH & Co. KG.

© Copyright by GERSTEL GmbH & Co. KG



Awarded for the active pursuit of environmental sustainability